

Sanitary manifold box. Classic installation.



CT3828.00 August 2021

- Plastic box.
- Removable cover included.
- Paintable cover
- Maximum adjustable height 100 mm.
- Can also be inserted in partition walls with 8 cm boxed structures, plastered on both sides.
- Brackets for fixing manifolds supplied separately.
- Removable frame 12 mm.



PRODUCTION RANGE

Code	Size LxH mm
3828.29.00	290x270
3828.39.00	390x270
3828.49.00	490x270

SPECIFICATIONS

3828 SERIES

3828 series plastic box for sanitary manifold suitable for classic installation with an external plate; removable cover included. Paintable cover. Maximum adjustable height 100 mm. Can also be inserted in partition walls with 8 cm boxed structures, plastered on both sides.

OVERALL DIMENSIONS

code 3828.29.00

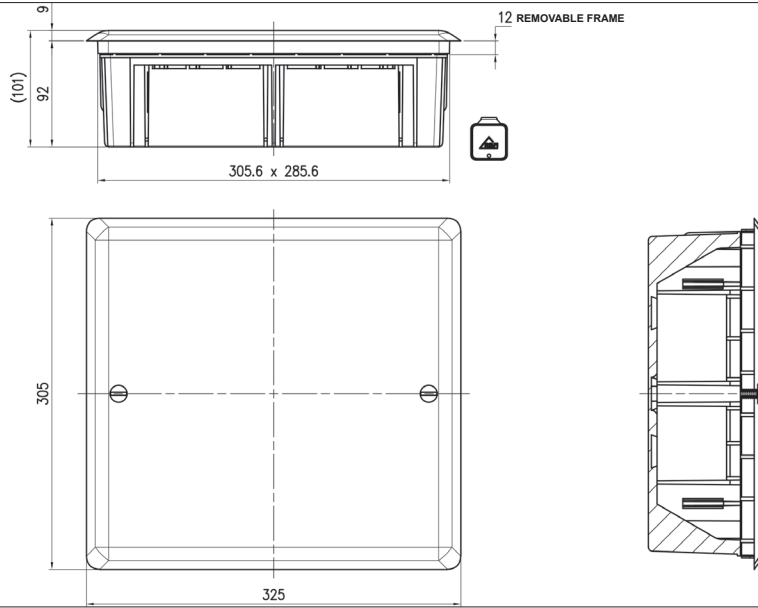

code 3828.39.00

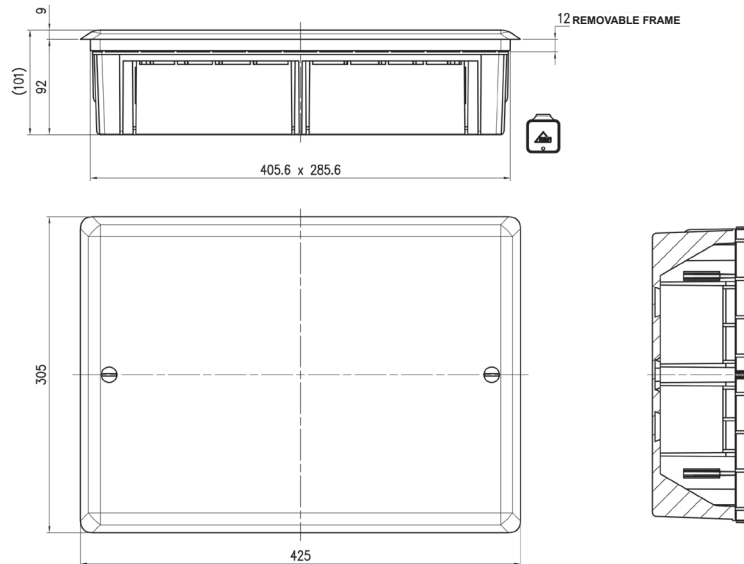

code 3828.49.00

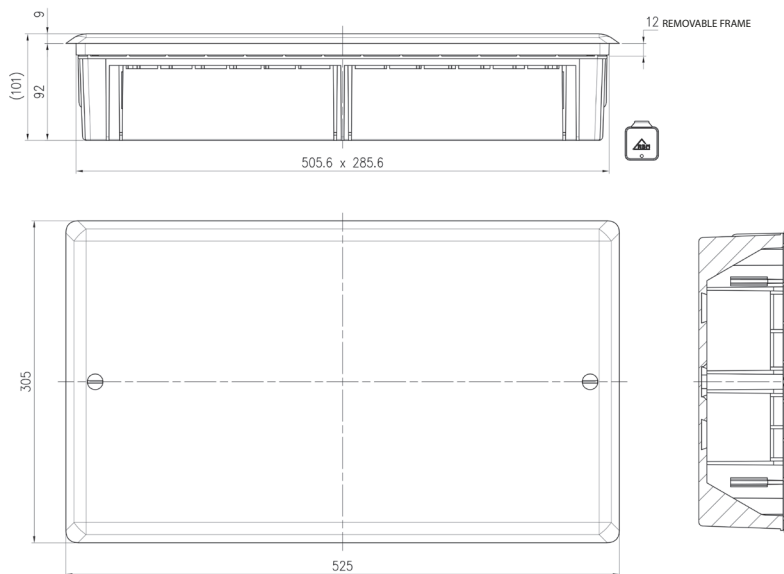

BOX 290X270

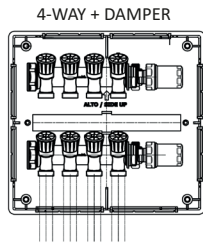
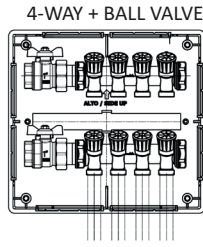
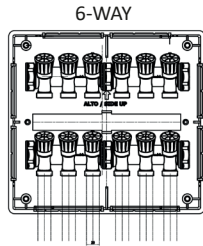

3-WAY + BALL VALVE angle 90°

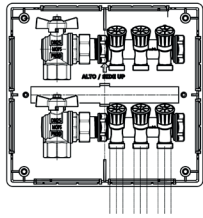

VALVE + 2-WAY + DAMPER

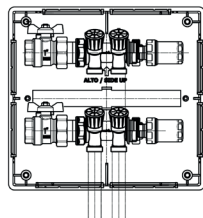

BOX 390X270

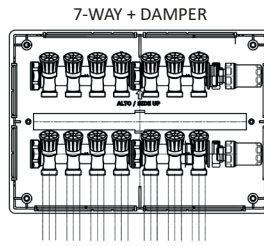
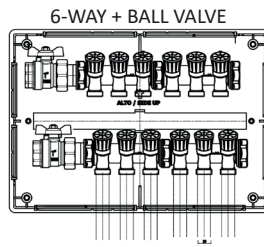
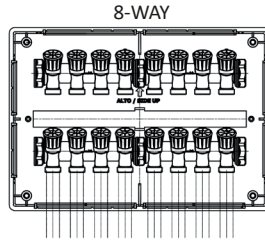

5-WAY + BALL VALVE angle 90°

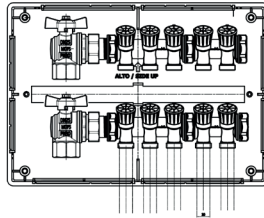

VALVE + 5-WAY + DAMPER

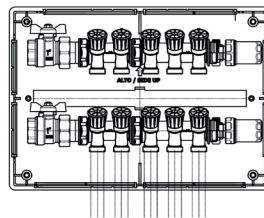

BOX 490X270

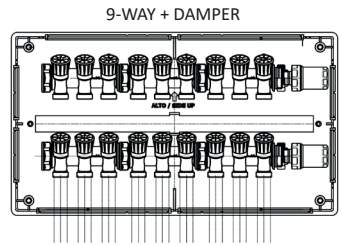
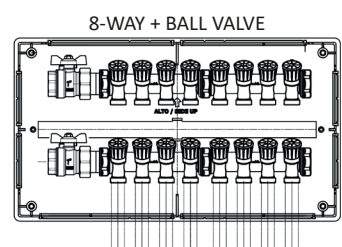
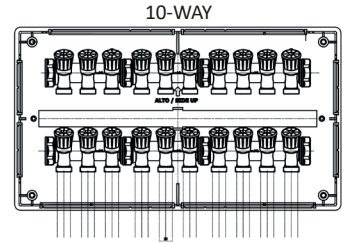

8-WAY + BALL VALVE angle 90°

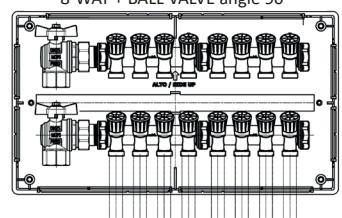

VALVE + 7-WAY + DAMPER

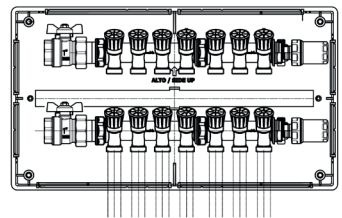

RBM spa reserves the right to improve and change the products described and relevant technical data at any moment and without prior notice. The information and pictures contained in this document are intended for information purposes only, are not binding and do not exempt the user in any case from strictly following the regulations in force and good practice standards.