



Rev. 03/2019

## **COMPACT POLYMER MANIFOLDS**

Floor heating.

# COMPACT POLYMER MANIFOLDS

Floor heating.



## PRODUCTION RANGE

N° Ways	Single manifold code		Rate of flow l/h	Possible field of use* (floor heating system)	
	Offtake Joints	Joints in Line		Heating at 10 °C kW exchangeable	Cooling at 5 °C kW exchangeable
2	Euroconus G 3/4" UNI-EN-ISO 228	F 1" UNI-EN-ISO 228	380	4,4	2,2
3	Euroconus G 3/4" UNI-EN-ISO 228	F 1" UNI-EN-ISO 228	570	6,6	3,3
4	Euroconus G 3/4" UNI-EN-ISO 228	F 1" UNI-EN-ISO 228	760	8,8	4,4
5	Euroconus G 3/4" UNI-EN-ISO 228	F 1" UNI-EN-ISO 228	950	11,0	5,5
6	Euroconus G 3/4" UNI-EN-ISO 228	F 1" UNI-EN-ISO 228	1.140	13,3	6,6
7	Euroconus G 3/4" UNI-EN-ISO 228	F 1" UNI-EN-ISO 228	1.330	15,5	7,7
8	Euroconus G 3/4" UNI-EN-ISO 228	F 1" UNI-EN-ISO 228	1.520	17,7	8,8
9	Euroconus G 3/4" UNI-EN-ISO 228	F 1" UNI-EN-ISO 228	1.710	19,9	9,9
10	Euroconus G 3/4" UNI-EN-ISO 228	F 1" UNI-EN-ISO 228	1.900	22,1	11,0
11	Euroconus G 3/4" UNI-EN-ISO 228	F 1" UNI-EN-ISO 228	2.090	24,3	12,1
12	Euroconus G 3/4" UNI-EN-ISO 228	F 1" UNI-EN-ISO 228	2.280	26,5	13,2
13	Euroconus G 3/4" UNI-EN-ISO 228	F 1" UNI-EN-ISO 228	2.470	28,7	14,3
14	Euroconus G 3/4" UNI-EN-ISO 228	F 1" UNI-EN-ISO 228	2.660	30,9	15,4

For the complete range of compositions available, refer to the instructions provided in the section "List Compositions" on page 11-13 of this technical data sheet.

\* The only reason for the table Possible field of Use is to provide to the technician with a rapid overall reference for associating the components chosen with a given heating or cooling system. This suggestion can be used for example, in making an estimate if no specific data is available or when carrying out approximate calculations.

## DESCRIPTION

### OBJECTIVE

The **RBM Polymer manifold for floor systems** enables parallel feed of terminal fluidic terminals with the following objectives and advantages:

- Limited dimensions that enable the insertion in boxes to be walled in partitioning walls
- Manual or automatic on-off interception of the single circuits, by applying electro thermal controls on the thermostatic valves that are controllable by thermostats and ambient chronothermostats.
- Micrometric regulation of the flow in transit, for balancing between the various circuits.
- Adjustment of the flow in transit for balancing between the various circuits by means of flowmeters mounted on the manifold and equipped with incorporated adjustment valve.
- Direct readout on flowmeter of the rate of flow in transit in the individual circuits
- Possibility of checking the performance of the circuits by inserting thermometers.

### THE PRODUCT

The **RBM Polymer manifold for floor systems** is supplied complete with the following preassembled accessories:

- Thermostatic interceptor valves

- Flowmeters for reading the flow with incorporated adjustment valve.
- A pair of brackets for fixing internally the control boxes (only for the compositions in the price list: see the relative section of this sheet).

### USE

They have found to be particularly adapted for feeding low temperature circuits serving radiant floor heating.

**N.B. For the correct installation of the polymer manifold provided with a flowmeter, refer to the explicit section of the present "installation" sheet.**

### ACCESSORIES

The versions of the **Polymer manifold for floor systems** can be equipped with a series of accessories, chosen from time to time, for the specific requirements of the designer and installer.

In the "Accessories" paragraph various connection possibilities to the terminal circuits are given.

It is advisable to remember that, in the testing and calibrating phase, **but above all in the case of disputes or dissents**, the presence of accessories, such as flowmeters and thermometers, may allow a rapid verification of the project operating parameters.

## CHARACTERISTIC DIMENSIONS

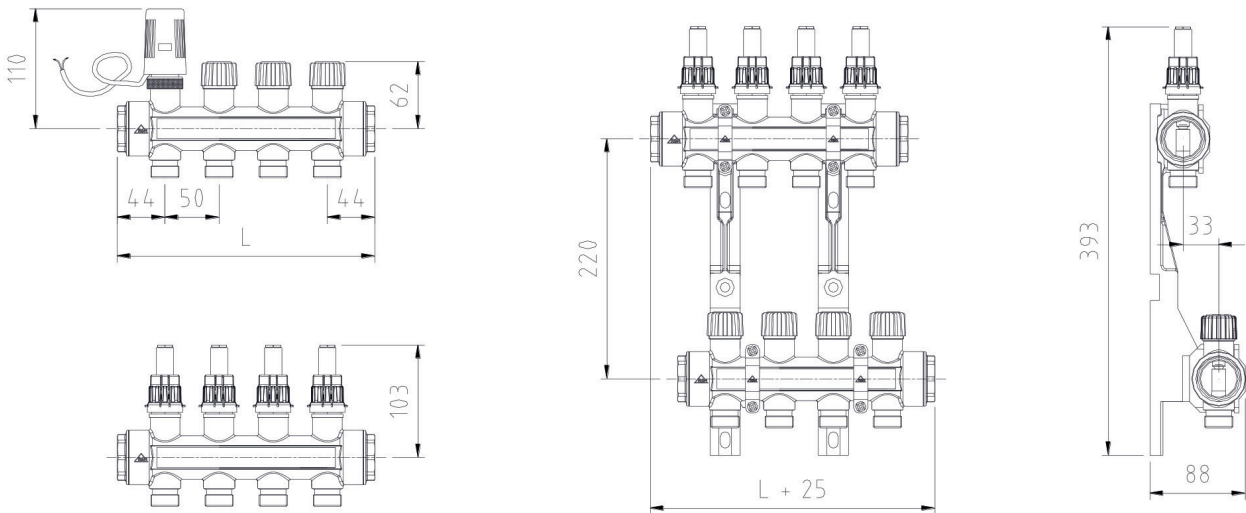

<b>N° ways</b>	2	3	4	5	6	7	8	9	10	11	12	13	14
<b>L [mm]</b>	138	188	238	288	338	388	438	488	538	648	698	748	798

## CONSTRUCTION CHARACTERISTICS

<b>Body</b>	Polymer (Pa66 + 30%FV) Brass inserts on the parts threaded
<b>Valve imperviousness</b>	EPDM
<b>Hand wheels and caps</b>	ABS
<b>Derivation connection</b>	Euroconus (G 3/4" UNI-EN-ISO 228)
<b>Connections on line</b>	F 1" UNI-EN-ISO 228

## TECHNICAL CHARACTERISTIC

<b>Max. working pressure</b>	800 KPa
<b>Max circuit test pressure (in temperature a 20°C)</b>	1000 KPa
<b>Differential pressure <math>\Delta p_{\max}</math> (only for thermostatic manifolds)</b>	100 kPa
<b>Temperature of use</b>	+5 ÷ +80 °C
<b>Fluid allowed</b>	Water; Water + glycol* 50%
<b>Flowmeter</b>	1 ÷ 4 l/min
<b>Flowmeter precision</b>	± 10%

\* Make sure that the antifreeze fluid or glycol used is not aggressive towards the O-rings, flow meters and construction materials of the manifold.

## DYNAMIC FLUID CHARACTERISTICS

### THERMOSTATIC VALVE AND SERVOMOTOR PRESSURE DROP

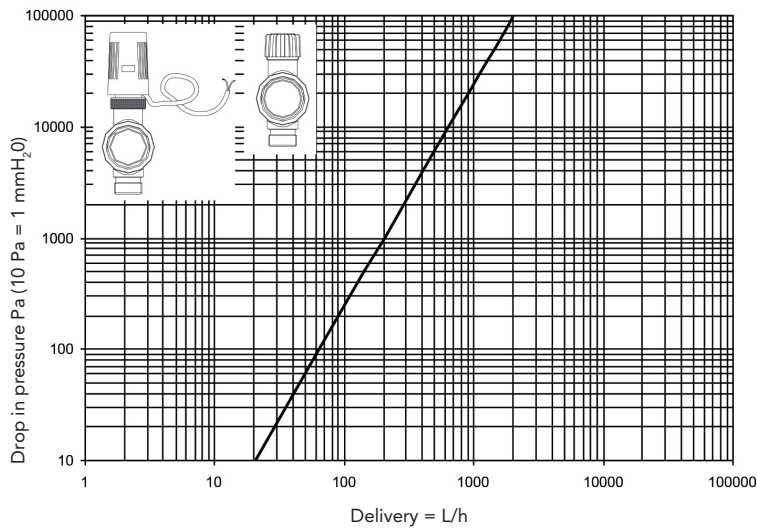

Analytical procedure to determine the drop in pressure for liquids with  $\rho \approx 1 \text{ kg/dm}^3$

$$\Delta P = \left( \frac{Q}{Kvs} \right)^2 \times 10.000 \quad \text{Valid for water with a temp. from 0 to 30 } ^\circ\text{C}$$

Correction of  $\Delta P$  for fluids with  $\rho$  different from  $1 \text{ kg/dm}^3$

$$\Delta P' = \Delta P \times \rho'$$

Thermostatic valve and Servomotor

Kv [m<sup>3</sup>/h]

2,050

### DROP IN PRESSURE OF THE FLOWMETER

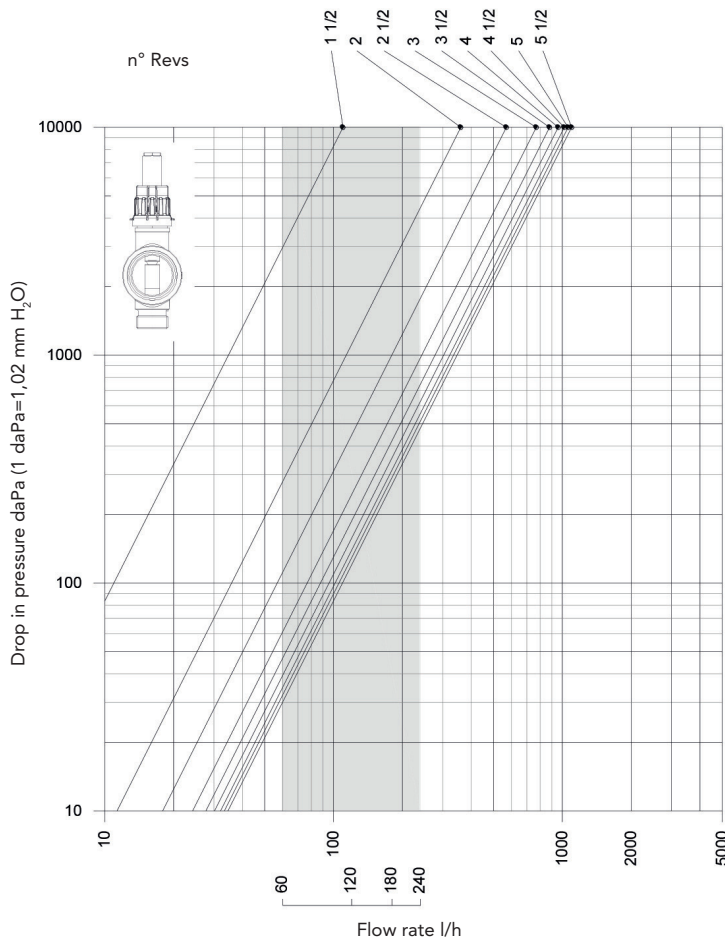

Flowmeter	
N° Revs	Kv [m <sup>3</sup> /h]
1/2	-
1	-
1 1/2	0,11
2	0,36
2 1/2	0,57
3	0,77
3 1/2	0,88
4	0,96
4 1/2	1,02
5	1,06
5 1/2	1,10
Flowmeter Open	

#### KEY

- $\Delta P$  drop in load in daPa
- $\Delta P'$  drop in load corrected in daPa
- $\Delta P_{\text{max}}$  difference of max pressure in kPa. Setting within which the electrothermic actuator guarantees a perfect seal when closed
- Q delivery in m<sup>3</sup>/h
- Kvs chydraulic characteristic in m<sup>3</sup>/h with valve open
- Kv hydraulic characteristic in m<sup>3</sup>/h for single revs
- $\rho'$  density of liquid in kg/dm<sup>3</sup>



**NOTE:** In balancing the circuits avoid excessive throttling of the flowmeters.

The turbulence generated in this condition can in fact cause irritating noise and vibration, together with an excessive dissolution of the gasses, the main cause of blockages in winding circuits (radiant floor systems).

In these cases reduce the difference between the more hydraulically advantageous circuits and those less favourable

by allocating the delivery of the latter between two or more circuits. To determine the total drop in pressure add the losses in delivery generated by the valve, the flowmeter and by the joints to the transit of the delivery of the single circuit. The drop in pressure generated by the manifold on transit of the overall delivery can be considered negligible compared to the drops in pressure generated by flowmeters and valves.

## INSTALLATION ADVICE

We advise complying with the following prescriptions when installing **RBM Polymer distribution manifolds**.

- Before connecting the **RBM Polymer distribution manifold**, wash all the tubes of the system upstream and downstream in order to remove any threading, welding, lubricant and solvent residue remaining in the heating circuit.
- Keep to the flow direction stamped on the individual accessories.
- Move the thermostatic valves and the flowmeters into the "all open" position.
- Pay particular attention to the filling of the circuit operations. Fill and remove air from one circuit at a time. For floor systems carefully follow the instructions provided by the manufacturer.
- The fluid circulating must be limpid and without suspensions which could damage the sealing seats of the plugs and/or deposit inside the manifolds and in the floor piping. If possible insert a suitable extractable well filter before the **RBM Polymer distribution manifold**.
- We recommend applying the protection of the inspection hole of the container boxes so as to avoid the deterioration of the surface covering during the plastering operations.

**ATTENTION:** in order to carry out the normal and correct pressure test of the system, it will not be necessary to remove any accessories from their seat (e.g. vent valves), but it will be sufficient to use the appropriate G1/4" threaded connections provided on the terminal drain cocks (see figure on page 9 of this sheet).

If it is necessary to remove/replace or loosen the air vent valve (automatic/manual) installed on the manifold's technopolymer un/loading units, it is sufficient to pull the valve by hand as far as it will go (0.4/0.8Nm torque), without the use of tools, such as spanners, etc. to ensure that it is sealed inside its seat. Apart from this, no sealing aid (e.g. Teflon, hemp, glue, etc.) must be used. Using such aids could lead to component failure and invalidate the product warranty.



**NOTE:** For additional information consult the optional accessories technical sheets, and comply with the installation instructions, use and maintenance provided in the enclosed instructions with the components supplied.

## USE OF FLOWMETER

The polymer manifold is present in the version with flowmeters and delivery adjustment valves incorporated.

The flowmeter present on the manifold is able to carry out the following operations:

- Measure the delivery: direct reading of the delivery quantity.
- Interception and adjustment of the delivery: possible thanks to the incorporated adjustment valve.

### USE

Using the incorporated adjustment valve in the flowmeter, the delivery of the individual circuits can be adjusted by the operator to the amount required, read directly on the indicator rod of the flowmeter, and by direct use of the same.

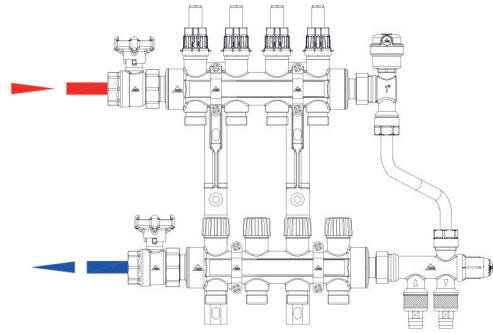

**Correct installation of manifold with flowmeter**

The flowmeter has a scale limit of 1 ÷ 4 l/min (60 ÷ 240 l/h).

Following the adjustment, the valve can be blocked in the position it is in by means of the blocking cover that acts also as a knob to adjust the flow, it is equipped for. The same valve enables the derivation way in question to be closed.

The **polymer manifold** with flowmeter **must always be positioned on the delivery side of the connected hydraulic system**. Incorrect positioning of the manifold causes malfunction of the flowmeter. The adjustment valve group and flowmeter is dismountable and replaceable with appropriate spare part (cod. **2250.00.12**).

## ADJUSTMENT – FUNCTION “MEMORY-STOP”

Locking system of the degree of opening of the flow meter, allowing at the re-opening of the circuit, the lock of the stroke at the exact position of initial setting (project value).

- 1. Set the regulation of the flow meter to the project value. The white handwheel has to be removed during this operation;**
- 2. Screw the ring of “Memory-Stop” counter-clockwise (left thread) until you reach the stop stroke;**
- 3. Replace the white handwheel. Operating on the handwheel (clockwise), you can close the single circuit. Turning on the opposite direction until its locking, you can open the circuit, until the setting of the project value.**

Through the two holes on the handwheel, you can plunge the flow meter, in order to avoid the tampering of the setting adjustment.

**Warning: DO NOT use tools for operation / adjustment of the flow meter, in order to undermine the correct working of it.**





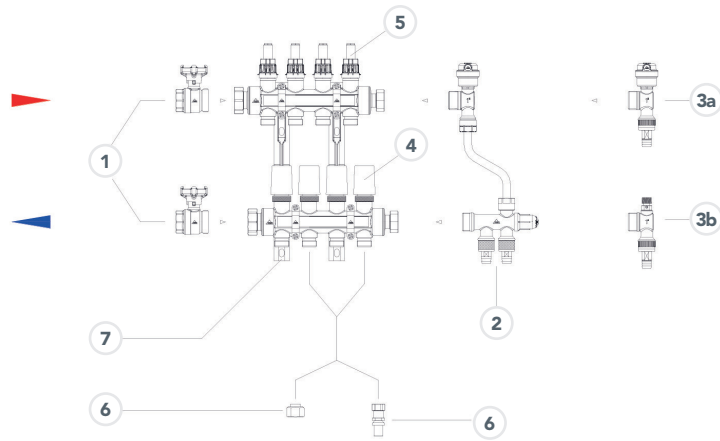

- 1 White cap**
- 2 Upper adjustment body**
- 3 Ring “Memory-Stop”**





## PRINCIPAL ACCESSORIES



Manifold composition: independent circuit distribution

Pos.	Product	Code	Accessory
1		861.06.053 861.06.043	Total passage ball valve for water, with incorporated water gauge. Pipe union 1" M
2		1529.06.00	Fixed By-Pass Group ( usable with manifolds mounted on misaligned brackets) Union 1" M
3a		449.06.50	End group for automatic discharge of air and water. Mounted on return manifold Union 1" M
3b		450.06.50	End group for manual discharge of air and water. Mounted on delivery side manifold. Union 1" M
4		306.00.X2	Servomotor and electrothermal command for thermostatic valves. With or without micro limit switch. Position Normally Closed valve when tension is lacking. Feed 230 V AC or 24 V AC
5		2250.00.12	Flow meter with regulation valve and flow rate indicator function. 1 ÷ 4 l/min (60 ÷ 240 l/h)
6		217.XX.X0 123.XX.00	Union for polyethylene tube $\phi$ 12 ÷ 21 mm thickness 1,1 ÷ 2,5 mm Threaded union F 3/4" Euroconus.



Pos.	Product	Code	Accessory
6		<b>224.XX.X0</b>	Union for multi-layer polyethylene tube 0 14 ÷ 20 mm thickness 2 ÷ 2,5 mm Threaded union F 3/4" Euroconus.
6		<b>963.XX.30</b>	Press-fit union for multi-layer polyethylene tube 0 14 ÷ 26 mm thickness 2 ÷ 3 mm Threaded union F 3/4" Euroconus.
7		<b>1528.06.00</b>	Pair of polymer brackets for misaligned fixing of manifolds complete with collar. Distance between centres 200 mm.

### EXAMPLES OF CONNECTIONS BETWEEN MANIFOLDS AND CONTAINER BOXES

Product	Metal box with plastic cover	Code	L x H
	<p>"Box1" Manifold in galvanised steel sheet containment and inspection box with bottom and side closures, complete with universal mobile bracket guides and removable cover in paintable plastic.</p> <ul style="list-style-type: none"> <li>Adjustable depth 80÷130 mm. (overall depth 80 ÷ 150 mm if considering the useful stroke of the screws used for fixing the plastic cover to the metal frame).</li> <li>Recessed assembly, even in walls with 80 mm box plastered on both sides.</li> </ul>	<b>2606.40.02</b>	400x500
		<b>2606.60.02</b>	600x500
		<b>2606.80.02</b>	800x500
		<b>2606.10.02</b>	1000x500

Product	Plastic box	Code	L x H
	<p>"Quickbox" Manifold in plastic containment and inspection box with bottom and side closures, complete with removable cover and independent collars running lengthwise inside the guides.</p> <ul style="list-style-type: none"> <li>Adjustable depth 80÷100 mm.</li> <li>Recessed assembly, even in walls with 80 mm box plastered on both sides.</li> </ul>	<b>1972.55.00</b>	550x450
		<b>1972.70.00</b>	700x450
		<b>1972.85.00</b>	850x450

## DISTRIBUTION MANIFOLDS COMPOSITION WITH AIR VENT VALVES

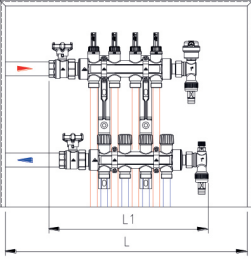
	2	3	4	5	6	7	8	9	10	11	12	13	14
	L1 (mm) 285	L1 (mm) 335	L1 (mm) 385	L1 (mm) 435	L1 (mm) 485	L1 (mm) 535	L1 (mm) 585	L1 (mm) 635	L1 (mm) 685	L1 (mm) 795	L1 (mm) 845	L1 (mm) 895	L1 (mm) 945
	L=400 <b>2606.40.02</b>		L=600 <b>2606.60.02</b>			L=800 <b>2606.80.02</b>			L=1000 <b>2606.10.02</b>				
	L=550 <b>1972.55.00*</b>			L=700 <b>1972.70.00*</b>			L=850 <b>1972.85.00*</b>		not available box Quickbox				

## COLLETTORI CON BY-PASS – NUMERO VIE COLLETTORI

	2	3	4	5	6	7	8	9	10	11	12	13
	L1 (mm) 370	L1 (mm) 420	L1 (mm) 470	L1 (mm) 520	L1 (mm) 570	L1 (mm) 620	L1 (mm) 670	L1 (mm) 720	L1 (mm) 770	L1 (mm) 880	L1 (mm) 930	L1 (mm) 980
	L=600 <b>2606.60.02</b>			L=800 <b>2606.80.02</b>			L=1000 <b>2606.10.02</b>					
	L=550 <b>1972.55.00*</b>		L=700 <b>1972.70.00*</b>			L=850 <b>1972.85.00*</b>		not available box Quickbox				

All the measurements, where not indicated, are to be considered in mm.

\* or housing in the box, use the dedicated brackets.  
When ordering the manifolds kit, check that it can be installed in Quickbox.

**NOTES:** To couple the manifold/containment boxes, a buffer area has been considered equal to:

- **30 mm** discharge/Bypass units side, to allow performing the required adjustments;
- **50 mm** ball valves side, required to allow installation of the multi-layer pipe and fitting.

If these requirements are not met, the coupling will skip to the next box size.

**For clearances of compositions out the standard not provided here, please contact the RBM Office.**

The compositions for the distribution with independent circuit controls can be made both with feed manifold positioned above the return one and vice versa (if a By-pass valve is used be careful to mount

it correctly)

The compositions with zone valve must be made exclusively with return manifold positioned above the feed one because the electric servo-control valve cannot be mounted upside down.

## INSTALLATION WARNINGS

The **manifold in RBM Kilma** polymer is supplied as a single body and cannot be separated from the individual components of which it is composed. Any disassembly of the individual components of the manifold body (brass and polymer) screwed on polymer seats is absolutely to be avoided, as well as any installation of components inside the same seats, where not expressly indicated, as this may void the warranty conditions of the product.

The only operations allowed are the assembly of accessories supplied loose inside the package (ball valves to be tightened only on

the revolving brass connections at the manifold inlet; system loading and unloading and vent or by-pass unit only on the outfeed polymer swivel), as per the instructions, and, if necessary, replacement of the flow lockshield valves with incorporated flow meter (code **2250.00.12**) and of the shutter units of the thermostatic valve (code **875.023**), to be carried out only by qualified personnel, in accordance with that prescribed by RBM Spa.

## COMPOSIZIONI A LISTINO

Code	N. Ways	Composition 1
1410.06.10	2	 <ul style="list-style-type: none"> <li>• n.1 multi way manifold group complete with flowmeters with holder function and flow indicator;</li> <li>• n.1 multi-way manifold group complete with thermostatic valves, with manual handwheel;</li> <li>• n.1 pair of polymer brackets for fixing.</li> </ul>
1411.06.10	3	
1412.06.10	4	
1413.06.10	5	
1414.06.10	6	
1415.06.10	7	
1416.06.10	8	
1417.06.10	9	
1418.06.10	10	
1419.06.10	11	
1420.06.10	12	
1420.13.10	13	
1420.14.10	14	

Code	N. Ways	Composition 2
1410.06.20	2	 <ul style="list-style-type: none"> <li>• n.1 multi way manifold group complete with flowmeters with holder function and flow indicator;</li> <li>• n.1 multi-way manifold group complete with thermostatic valves, with manual handwheel;</li> <li>• n.1 pair of polymer brackets for fixing;</li> <li>• n.2 ball valves 1" with built-in thermometer 0-80 °C;</li> <li>• n.2 joint fittings;</li> <li>• n.1 automatic air / water discharge terminal unit 1".</li> <li>• n.1 manual air / water discharge terminal unit 1".</li> </ul>
1411.06.20	3	
1412.06.20	4	
1413.06.20	5	
1414.06.20	6	
1415.06.20	7	
1416.06.20	8	
1417.06.20	9	
1418.06.20	10	
1419.06.20	11	
1420.06.20	12	
1420.13.20	13	
1420.14.20	14	

Code	N. Ways	Composition 3
1410.06.50	2	
1411.06.50	3	
1412.06.50	4	
1413.06.50	5	
1414.06.50	6	
1415.06.50	7	
1416.06.50	8	
1417.06.50	9	
1418.06.50	10	
1419.06.50	11	
1420.06.50	12	
1420.13.50	13	

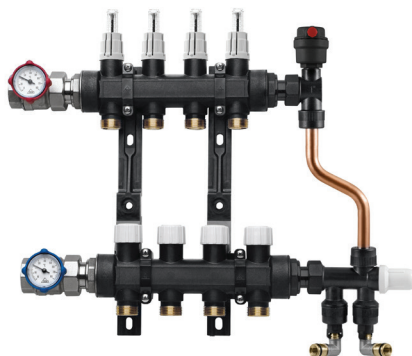

- n.1 multi way manifold group complete with flowmeters with holder function and flow indicator;
- n.1 multi-way manifold group complete with thermostatic valves, with manual handwheel;
- n.1 pair of polymer brackets for fixing;
- n.2 ball valves 1" with built-in thermometer 0-80 °C;
- n.2 joint fittings;
- n.1 automatic air vent valve 3/8";
- n.1 adjustable bypass valve complete with connections to fill system.

## COMPOSITION FOR MODULAR CONTROL UNITS KIT

The compositions shown below, without shut-off ball valves, can be used for the composition of the modular Kilma control units. Can be coupled to the mixing units Kilma EVO / ECO.

Code	N. Ways	Composition 1
1410.06.40	2	 <ul style="list-style-type: none"> <li>• n.1 multi way manifold group complete with flowmeters with holder function and flow indicator;</li> <li>• n.1 multi-way manifold group complete with thermostatic valves, with manual handwheel;</li> <li>• n.1 pair of polymer brackets for fixing;</li> <li>• n.2 thermometer 0-80 °C;</li> <li>• n.2 joint fittings;</li> <li>• n.1 automatic air / water discharge terminal unit 1";</li> <li>• n.1 manual air / water discharge terminal unit 1".</li> </ul>
1411.06.40	3	
1412.06.40	4	
1413.06.40	5	
1414.06.40	6	
1415.06.40	7	
1416.06.40	8	
1417.06.40	9	
1418.06.40	10	
1419.06.40	11	
1420.06.40	12	
1420.13.40	13	
1420.14.40	14	

Code	N. Ways	Composition 2
1410.06.70	2	 <ul style="list-style-type: none"> <li>• n.1 multi way manifold group complete with flowmeters with holder function and flow indicator;</li> <li>• n.1 multi-way manifold group complete with thermostatic valves, with manual handwheel;</li> <li>• n.1 pair of polymer brackets for fixing;</li> <li>• n.2 thermometer 0-80 °C;</li> <li>• n.2 joint fittings;</li> <li>• n.1 automatic air vent valve 3/8";</li> <li>• n.1 adjustable bypass valve complete with connections to fill system.</li> </ul>
1411.06.70	3	
1412.06.70	4	
1413.06.70	5	
1414.06.70	6	
1415.06.70	7	
1416.06.70	8	
1417.06.70	9	
1418.06.70	10	
1419.06.70	11	
1420.06.70	12	
1420.13.70	13	

## SYSTEM LOADING / UNLOADING

The terminal units and the by-pass unit are equipped with a filling unit with threaded pressure gauge holder connection F G 1/8".



Use a manometer  $\varnothing$  40 with a 16 bar G1/8" radial coupling code **7469.005** for connection to automatic/manual thermal units.



Use a  $\varnothing$  40 pressure gauge with a 10 bar G1/8" axial coupling code **832.005** for connection to the by-pass unit.

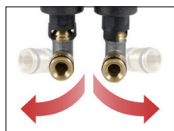

By-pass unit with rotatable elbow fittings to facilitate loading / unloading the system.

## POSSIBLE APPLICATIONS

### FEELING RADIANT FLOOR SYSTEM

Thermal zone with bath thermally independent even during functioning timer (e.g. sleeping area mitigated, bathroom warmed).

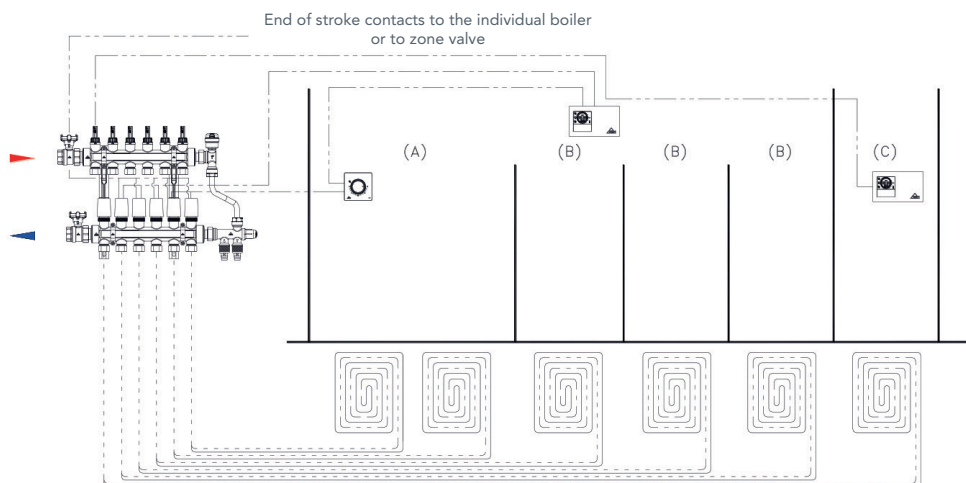

- (A)** Circuits thermally independent even during functioning times (e.g. sleeping area mitigated, bathroom warmed).
- (B)** Areas controlled by the chronothermostat in the thermal zone.
- (C)** Bathroom controlled by independent chronothermostat.



Use CHxxx key to open/close the tap

- 1 Socket for pressure gauge G 1/4" F



Use CHxxx key to open/close the taps

- 1 Interception holder
- 2 Socket for pressure gauge G 1/4" F

*RBM spa reserves the right to improve and change the products described and relevant technical data at any moment and without prior notice. The information and images contained in this document are intended for information purposes only, are not binding and in any case do not exempt the user from strictly following the regulations in force and good practice standards.*