



Rev. 07/2021

THERMOSTATIC RADIATOR VALVES

For iron, copper, polyethylene and multilayer pipe.

THERMOSTATIC RADIATOR VALVES

For iron, copper, polyethylene and multilayer pipe.

LICENSED USE OF TRADEMARK NR. 43



PRODUCTION RANGE

Model	Size	Plant connect.	IRON PIPE					
			Code		Radiator connect.	Code		Radiator connect.
			Polymer cap unit	Brass cap unit		Polymer cap unit	Brass cap unit	
ANGLE	3/8"	G 3/8" F	31.03.00*	2494.03.00*	G 3/8" M RFS	31.03.90*	2494.03.90*	G 3/8" M
ANGLE	1/2"	G 1/2" F	31.04.00*	2494.04.00*	G 1/2" M RFS	31.04.90*	2494.04.90*	G 1/2" M
ANGLE	3/4"	G 3/4" F	-	-	G 3/4" M RFS	31.05.00	-	G 3/4" M
STRAIGHT	3/8"	G 3/8" F	32.03.00*	2495.03.00*	G 3/8" M RFS	32.03.90*	2495.03.90*	G 3/8" M
STRAIGHT	1/2"	G 1/2" F	32.04.00*	2495.04.00*	G 1/2" M RFS	32.04.90*	2495.04.90*	G 1/2" M
STRAIGHT	3/4"	G 3/4" F	-	-	G 3/4" M RFS	32.05.00	-	G 3/4" M
INVERSE	3/8"	G 3/8" F	179.03.00	-	G 3/8" M RFS	-	-	G 3/8" M
INVERSE	1/2"	G 1/2" F	179.04.00	-	G 1/2" M RFS	-	-	G 1/2" M
REVERSIBLE ANGLE	3/8"	G 3/8" F	395.03.00	395.03.10	G 3/8" M RFS	395.03.90	-	G 3/8" M
REVERSIBLE ANGLE	1/2"	G 1/2" F	395.04.00	395.03.10	G 1/2" M RFS	395.04.90	-	G 1/2" M

MULTILAYER, POLYETHYLENE, COPPER PIPE

Model	Size	Plant connect.	Code		Radiator connect.	Code		Radiator connect.
			Polymer cap unit	Brass cap unit		Polymer cap unit	Brass cap unit	
ANGLE	3/8"	Standard RBM	48.03.00*	2496.03.00*	G 3/8" M RFS	48.03.90*	2496.03.90*	G 3/8" M
ANGLE	1/2"	Standard RBM	48.04.00*	2496.04.00*	G 1/2" M RFS	48.04.90*	2496.04.90*	G 1/2" M
STRAIGHT	3/8"	Standard RBM	49.03.00*	2497.03.00*	G 3/8" M RFS	48.03.90*	2497.03.90*	G 3/8" M
STRAIGHT	1/2"	Standard RBM	49.04.00*	2497.04.00*-	G 1/2" M RFS	48.04.90*	2497.04.90*	G 1/2" M
INVERSE	3/8"	Standard RBM	180.03.00	-	G 3/8" M RFS	-	-	G 3/8" M
INVERSE	1/2"	Standard RBM	180.04.00	-	G 1/2" M RFS	-	-	G 1/2" M

THERMOSTATIC HEADS



PRODUCTION RANGE

Model (series)	Code	Sensor	Sensor cable length
TL8 (305)	305.00.00	Liquid expansion	- (incorporated)
TL10 (590)	590.00.00*	Liquid expansion	- (incorporated)
TL20 (590.00.10)	590.00.10*	Gas expansion	2 metres
TL30 (720)	720.00.30*	Liquid expansion	- (incorporated)
TL70 (2633)	2633.00.00*	Liquid expansion	- (incorporated)
- (2634)	2634*	Liquid expansion	- (incorporated)
TL10W (3087)	3087.00.00*	Liquid expansion	- (incorporated)
- (3614)	3614	Liquid expansion	- (incorporated)

THERMOSTATIC RADIATOR VALVES - DESCRIPTION

USE

The **RBM thermostatic valves** are used as shut-off and control for radiators, fan coils, radiant panels, etc. in heating systems.

PRODUCTION RANGE

The valves are manufactured in the straight, angle and inverse versions allowing connection to different types of piping, on plant side.

- To plant side, gas thread valves are suitable for connection with steel pipe.
- To plant side, RBM Standard thread valves are suitable for connection with copper pipe, polyethylene pipe and multilayer polyethylene pipe for which specific fittings are prepared.

On radiator side, the range is fitted with "RFS" mechanical hermetic junction system for quick connection with the heating body. The hermetic junction system consists of a PTFE gasket with fastening nut.

OPERATION

The **RBM thermostatic valves** must be installed **respecting the flow direction**.

To avoid jeopardising the RBM thermostatic valves' (thermostatic valves + thermostatic head) operation, they can only be assembled on the system in horizontal position and not in other positions.

The hydraulic features and head losses of the RBM valves are found on the technical sheet's diagrams, under the "Fluid dynamics features" section.

THERMOSTATIC RADIATOR VALVES - CONSTRUCTION FEATURES

Body:	brass
Adjustment cap:	polymer or brass
Seals:	EPDM PEROX ed NBR
Handwheel:	shockproof ABS
Connection to end:	RFS Connection®
RFS Connection®:	M UNI-EN-ISO 228 with PTFE olive
Surface finish:	nickel-plated and satin

THERMOSTATIC RADIATOR VALVES - TECHNICAL FEATURES

Working T_{max}:	110 °C
Working P_{max}:	10 bar (1000 kPa)
Fluid:	water and water + glycol at 50%

THERMOSTATIC HEAD - DESCRIPTION

The **RBM thermostatic head** is a control device for thermostatic valves.

The thermostatic head mainly consists of a case underneath the handwheel, containing the thermostatic liquid, sensitive to room temperature variations.

The thermostatic liquid tends to vary its volume upon room temperature increase or decrease, causing the valve's shutter connected to

it, to move, in this way adjusting the liquid flow towards the heating body.

Said movements maintain the temperature set from the thermostatic head handwheel throughout time.

The thermostatic head components are made of plastic, therefore the heat dispersed by the heating body does not affect the thermostatic head's mechanism.

THERMOSTATIC HEAD - CONSTRUCTION FEATURES

Body:	polycarbonate
Bulb liquid:	thermostatic ethyl-acetate
TL8 Type:	with liquid expansion, incorporated sensor
TL10 Type:	with liquid expansion, incorporated sensor
TL20 Type:	with gas expansion, remote sensor - sensor cable length: 2m
TL30 Type:	with liquid expansion, incorporated sensor
TL70 Type:	with liquid expansion, incorporated sensor
2634 Type:	with liquid expansion, incorporated sensor
TL10W Type:	with liquid expansion, incorporated sensor
3614 Type:	with liquid expansion, incorporated sensor



CERTIFICATIONS OF CONFORMITY

The **RBM thermostatic valves** and the **thermostatic heads** comply with the Italian Ministerial Decree 17 February 2007 bearing:

Dispositions on deductions for existing building heritage energy re-qualification, pursuant to art. 1, comma 349, of Law 27 December 2006 no. 296 art. 9 -1/b, as certified in accordance with **European Standard UNI EN 215 "Thermostatic valves for radiators. Requirements and test methods"**.

The Standard conformity certifications are guaranteed by the certificates **granting use of trademark no. 43, issued by the certifying body**.

THERMOSTATIC VALVE UNI - EN 215 APPROVED

Technical features RBM thermostatic head and thermostatic valve		Stated values
Minimum adjustment calibration (anti-freeze position)	t_s min	7 °C (*)
Maximum adjustment calibration (position)	t_s max	30 °C (5)
Saving condition (position)		20 °C (3)
Maximum working pressure	PN	10 bar (1000 kPa)
Maximum differential pressure (direction of delivery)	ΔP	1 bar (100 kPa)
Maximum differential pressure (direction of return)	ΔP	0,6 bar (60 kPa)
Nominal capacity "q _m N" (DP = 10 KPa) angle - straight	q _m N	220 Kg/h
Control accuracy according to EN 215 (TL8, TL10, TL20, TL30, 2634, TL10W, 3614) - for valves with polymer cap unit	CA	0.2 K
Control accuracy according to EN 215 (TL8, TL10, TL20, TL30, 2634, TL10W) - for valves with brass cap unit	CA	0.6 K
Control accuracy according to EN 215 (TL70) – for valves with polymer and brass cap unit	CA	0.6 K
Maximum working temperature		110 °C
Maximum storage temperature		50 °C
Hysteresis	C	0.3 K (TL8 - TL10 - TL30 - TL70 - 2634 - TL10W -3614) 0.4 K (TL20)
Authority	a	0,9
Response time	Z	25 min (TL8 - TL10 - TL30 - TL70 - 2634 - 3614) 20 min (TL20) 32 min (TL10W)
Differential pressure influence	D	0.2 K (TL8 - TL10 - TL30 - TL70 - 2634 - TL10W - 3614) 0.3 K (TL20)
Water temperature influence		
Declared values in combination to valves with polymer cap unit	W	0,10 (TL10W) 0,20 K (TL20) 0,45 K (TL8 - TL30 - 3614) 0,50 K (TL10 - 2634) 0,70 K (TL70)
Declared values in combination to valves with brass cap unit	W	1,00 K (TL8 - TL10 - TL30 - TL70 - 2634) 0,20 K (TL20) 0,10 K (TL10W)
The thermostatic valve is fitted with manual adjustment handwheel (rotation)		60° = 1K
Thermostatic valve conform with Standard EN 215		 028
RBM thermostatic head conform with Standard EN 215		 028

The certification of the valves, carried out by **Siet** according to the UNI EN 215 standard, is intended as the combination of valve and RBM thermostatic head. Energy efficient RBM thermostatic head: **Class I** (TELL) approved.



TELL

Thermostatic Efficiency Label

Manufacturer: R.B.M. S.p.A.
 Product: 2634
 Reg.-No.: 10590-20160422

Energy

I

II

III

IV

V

VI

www.tell-online.eu
 A label of EUnited Valves
 European Valve Manufacturers Association

DIMENSIONAL FEATURES

STRAIGHT VALVE for iron pipe						STRAIGHT VALVE for multilayer, polyethylene, copper pipe						
Code	G Meas.	A [ø]	B [mm]	C [mm]	D [mm]	Code	ø1	ø2 *	A [ø]	B [mm]	C [mm]	D [mm]
32.03.X0	3/8"	35.5	70	22.5	48.5	49.03.X0	3/8"	RBM	35.5	70	23.5	48.5
32.04.X0	1/2"	35.5	70	24.5	50	49.04.X0	1/2"	RBM	35.5	70	23.5	50
32.05.00	3/4"	35.5	70	31.5	58.5							

* RBM Standard Thread W24.5x19F



**ANGLE VALVE
for iron pipe**

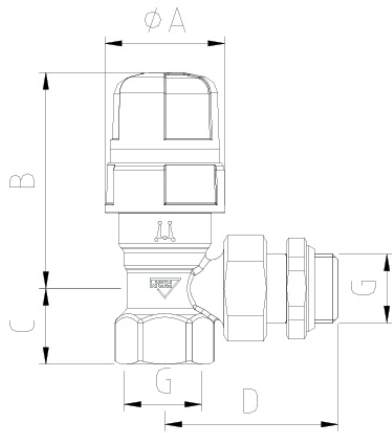

Code	G Meas.	A [ø]	B [mm]	C [mm]	D [mm]
31.03.X0	3/8"	35.5	66	19.5	50
31.04.X0	1/2"	35.5	66	22.5	51.5
31.05.00	3/4"	35.5	66	28	62.5

**ANGLE VALVE
for multilayer, polyethylene, copper pipe**

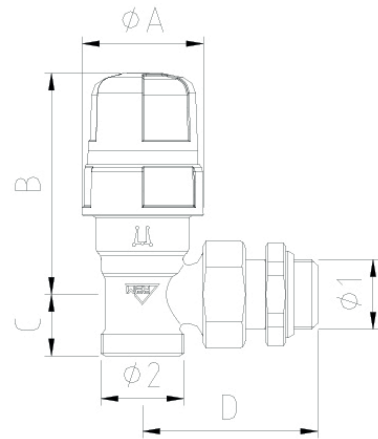

Code	Ø1	Ø2 *	A [ø]	B [mm]	C [mm]	D [mm]
48.03.X0	3/8"	RBM	35.5	66	18	50
48.04.X0	1/2"	RBM	35.5	66	18	51.5

* RBM Standard Thread W24.5x19F

**INVERSE VALVE
for iron pipe**

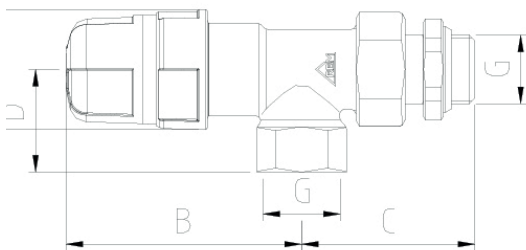

Code	G Meas.	A [ø]	B [mm]	C [mm]	D [mm]
179.03.X0	3/8"	35.5	70.5	47.5	29
179.04.X0	1/2"	35.5	70.5	51.5	30.5

**INVERSE VALVE
for multilayer, polyethylene, copper pipe**

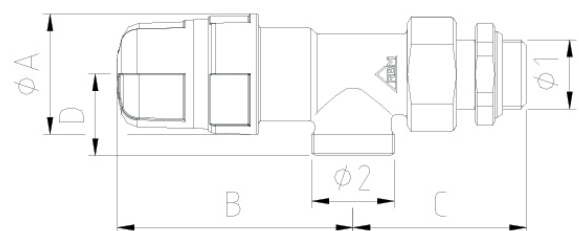

Code	Ø1	Ø2 *	A [ø]	B [mm]	C [mm]	D [mm]
180.03.X0	3/8"	RBM	35.5	69.5	49	24
180.04.X0	1/2"	RBM	35.5	69.5	52.5	24

THERMOSTATIC HEAD

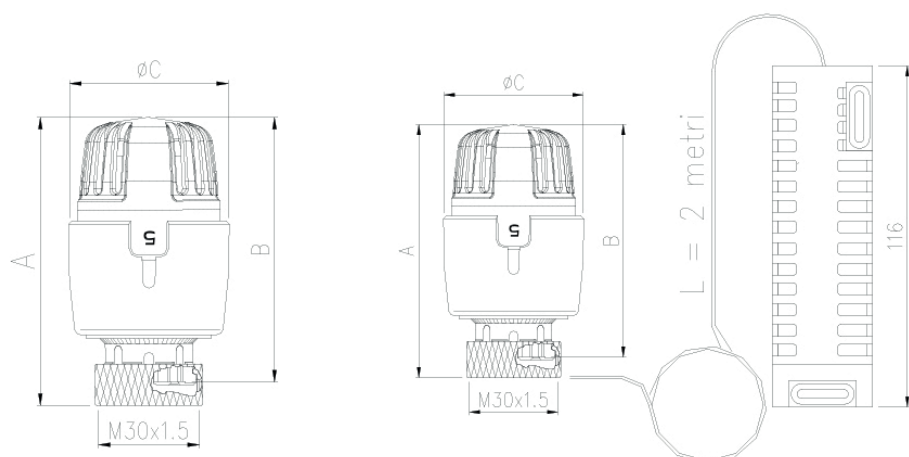

Code	Anti-freeze position (*)			Open position (5)		
	A [mm]	B [mm]	C [mm]	A [mm]	B [mm]	C [mm]
305.00.00	81	74	47	86	79	47
590.00.00	81	74	47	86	79	47
720.00.30	82.5	75.5	47	87.5	80.5	47
2633.00.00	81	74	47	86	79	47
2634.00.00	83	76	47	88	81	47
3087.00.00	93	87	47	98	92	47
590.00.10	81	74	47	86	79	47

All measurements, where not indicated, must be considered in mm.

VALVE FLUID HYDRAULIC CHARACTERISTIC

3/8" ANGLE VALVE

1/2" ANGLE VALVE

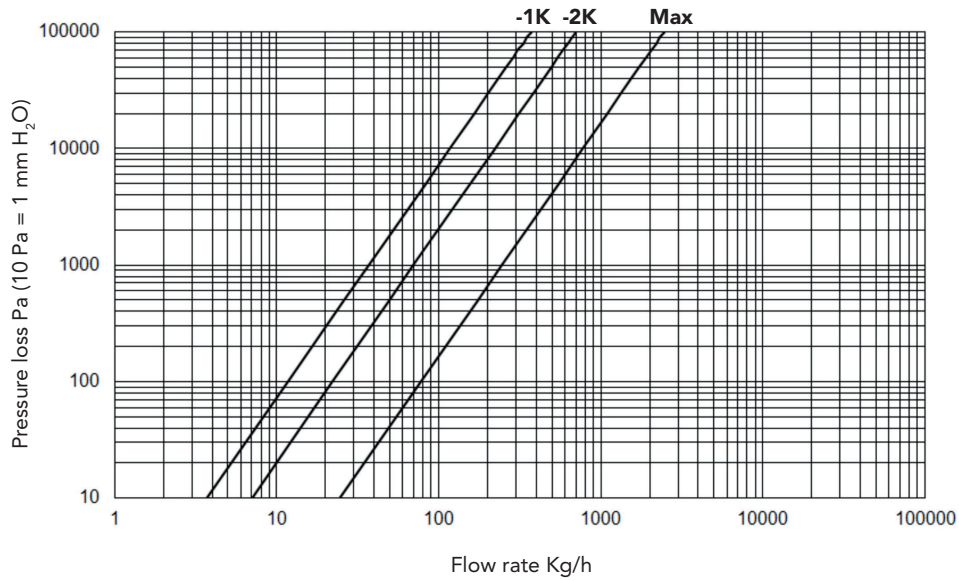

Value	Kv [Kg/h]
-1K	370
-2K	700
Max	2450

3/8" STRAIGHT VALVE

1/2" STRAIGHT VALVE

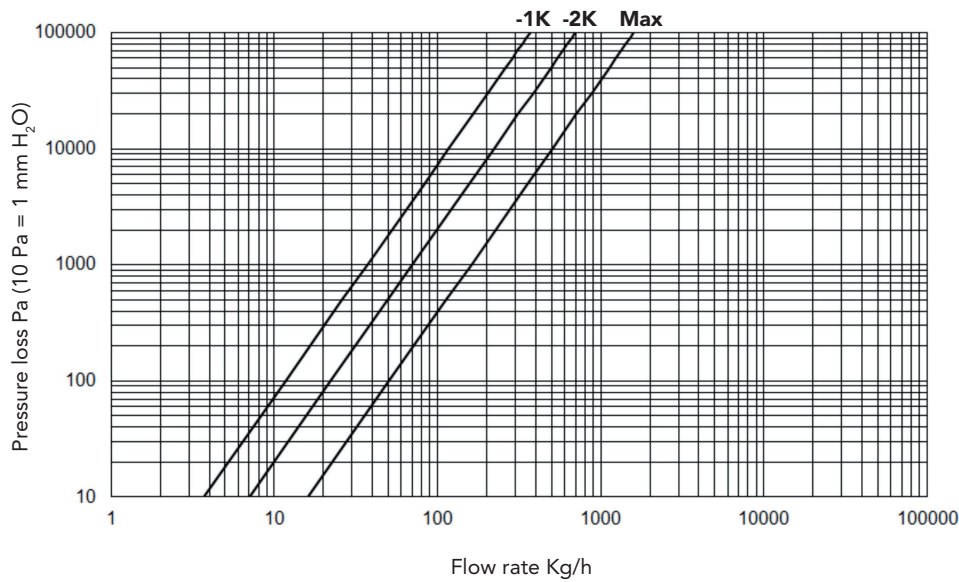

Value	Kv [Kg/h]
-1K	370
-2K	700
Max	1600

3/8" INVERSE VALVE
1/2" INVERSE VALVE

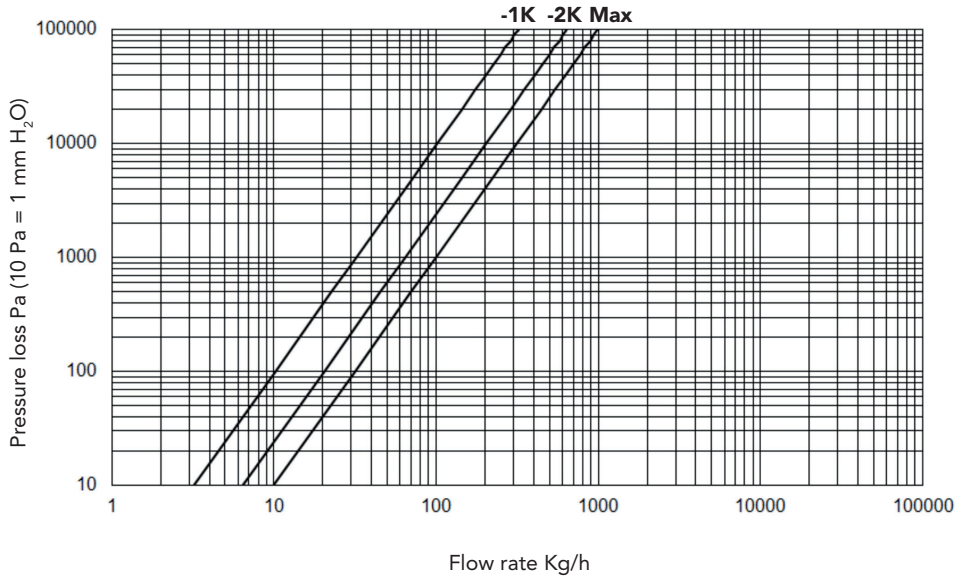

Value	Kv [Kg/h]
-1K	320
-2K	640
Max	990

THERMOSTATIC HEAD ASSEMBLY ON THERMOSTATIC VALVE

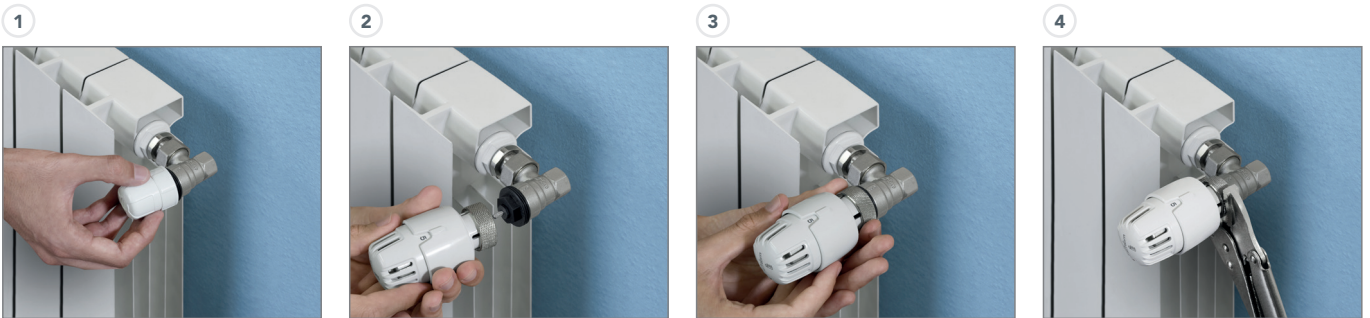

1. Remove the manual adjustment handwheel by loosening it anti-clockwise.

2. Position the polymer spacer onto the valve's body by centring the cap's hexagon (**this operation is necessary only for the 3087 series** thermostatic head - the spacer is supplied as a kit with the thermostatic head).

Bring the thermostatic head's numbered knob to **position "5"**, reached by turning it anti-clockwise.

3. Position the thermostatic head onto the valve's body by centring the cap's hexagon and leaving the adjustment reference window upwards (in visible position).

4. Tighten the thermostatic head's knurled metal ring nut onto the valve's body until blocked. Turn the numbered knob a few times after head assembly, from **position "5"** to **position "*"**, for the parts to settle.

THERMOSTATIC HEAD WITH REMOTE SENSOR

Where the heating body is located where the heat stores, e.g. behind curtains, inside cabinets, underneath shelves or where solar radiations directly cover the valve, use the **thermostatic head with sensor at a distance (mod. TL 20 code 590.00.10)**.

This allows placing the sensitive element in the most suitable place to correctly detect room temperature.



TEMPERATURE ADJUSTMENT

Adjust by turning the numbered knob so the symbol corresponding to the wanted temperature is positioned in the window of reference. (Approximate values)

Symbol	*	1	2	3	4	5
Value °C	7	10	15	20	25	30

(*) Indicates the anti-freeze position where the valve only opens when the room temperature drops below 7°C.

It is recommended during long winter absence or when wanting to ventilate the room.

WARNING

It is a good rule to **remove the RBM thermostatic head from the valve during the summer, when the heating system is inactive**, to protect the RBM thermostatic head's good operation.

STORAGE

Product storage: -25 ° C ÷ + 50 ° C in original packaging.

TEMPERATURE LIMIT

We recommend blocking the knob at the temperature or limit its field of intervention, once temperature is adjusted.

Example of handwheel blocking on position: **"3" (20°C)**.

- Highlight no. 3 in the symbols' display window;
- The knob is set-up with numbers referring to the temperature adjusted by the thermostatic head;
- Search for no. 20 (corresponding to 20°C);
- Introduce the relative inserts in the compartments near no. 20;
- The knob will remain blocked on the position of symbol **"3"**.

Move the inserts to wanted positions, if wanting to limit adjustment to a higher value.

Use the specific inserts **code 209.00.00** available as accessory, to block or limit movement.

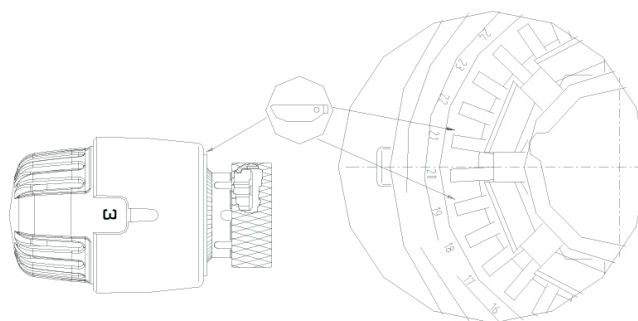

MAINTENANCE INTERVENTIONS

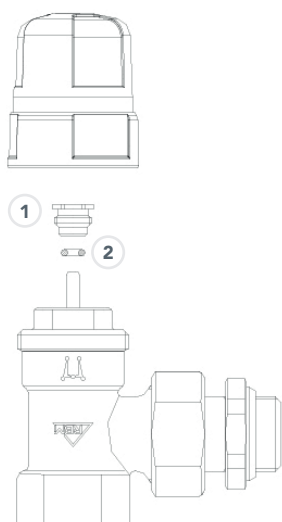

Maintenance interventions can be carried out on all RBM thermostatic valves.

In fact, the valve's OR can be replaced with system running.

Follow the indications below:

- Loosen the valve's handwheel anti-clockwise. Remove the handwheel, uncover the packing gland housing an OR gasket to replace.
- Using specific CH 10 wrench, loosen the packing gland and replace the OR with RBM OR (**code. 5001.045**).
- Appropriately dispose of the replaced OR.
- Using the specific wrench, tighten the packing gland up to the stop and then the valve's handwheel.

1 Stem nut

2 OR Seal

INSTALLATION WARNINGS

It is recommended to assemble the thermostatic head in **horizontal position**.

The thermostatic valves' sensitive element must not be installed in niches, boxes, behind curtains, or directly exposed to sunlight.

The temperature detected by the sensitive element could be altered in case the installation is not following the above recommendations.

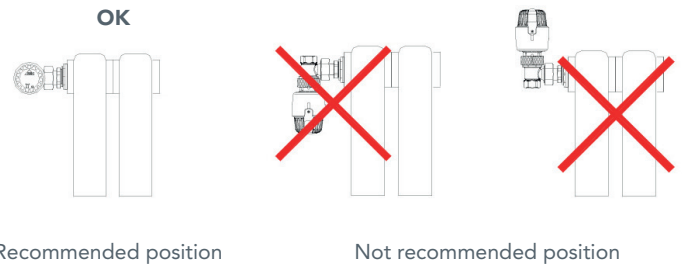

VANDAL PROOF COLLAR

The **RBM thermostatic head** can be fitted with **vandal proof collar** (code **316.00.10 - fig.1**), that mounted, prevents its removal. Only by using the supplied specific **wrench** (code **2151.005 - fig.2**), is it possible to remove it.

(Kit 1+2 code **316.00.00**).



VANDAL PROOF AND ANTI-TAMPERING KNOB FOR THERMOSTATIC HEAD

The RBM thermostatic head can also be fitted with a **vandal proof and antitampering knob** (code **2274.005 - fig.1**) that mounted, prevents its tampering.

The knob is also fitted with specific **tool** (code **2273.005 - fig.2**) for its assembly, to be purchased separately.



SERVOMOTOR FOR THERMOSTATIC VALVE

A servomotor for electrothermally controlled valves (code **306.00.x2**), can be used if wanting to control the **thermostatic valve's** opening and closing.

The servomotor is applied on the valve by means of the present threaded ring nut.

There are two types of electrothermally controlled servomotors: 2 wires (code **306.00.02** power supply 230V AC, **306.00.12** power supply 24V AC) and 4 wires (code **306.00.42** power supply 230V AC, **306.00.52** power supply 24V AC) with auxiliary microswitch.

The servomotor brings the normally closed valve to pressure, when without voltage.

The servomotor can be connected to a room temperature control device like a timed thermostat or room thermostat, adjusting its opening and closing. Refer to the wiring diagrams of the chosen control and command devices' technical sheets, for the electric connection between servomotor and valve.



COMBINED FITTINGS

POLYETHYLENE PIPING

Type of fitting	Number of Threaded connections	Type of threaded connection	Piping	Code
FITTING A TIGHTEN	1	Standard RBM Nut	POLYETHYLENE	71.12...20.X0 122.12...20.00

MULTILAYER POLYETHYLENE PIPING

Type of fitting	Number of Threaded connections	Type of threaded connection	Piping	Code
FITTING A TIGHTEN	1	Standard RBM Nut	MULTILAYER POLYETHYLENE	70.10...20.X0 1216.14...16.00

Type of fitting	Number of Threaded connections	Press connections	Piping	Code
FITTING A PRESS	1 Standard RBM	1	MULTILAYER POLYETHYLENE	826.14...20.X0

COPPER PIPING

Type of fitting	Number of Threaded connections	Type of threaded connection	Piping	Code
FITTING A TIGHTEN	1	Standard RBM Nut	COPPER	602.10...16.00 41.10...16.20 41.18.20* (Ø18 pipe only)

* Provide a reduction, code 57.18.00, for fitting connection for copper pipe Ø18

ACCESSORIES

Product	Code	Description
	2274.005	Vandal proof and antitampering knob (Package includes one tool code 2273.005)
	2273.005	Specific tool for assembling the vandal proof knob (Tool provided with number 12 fixing screws)
	316.00.10	Vandal proof collar
	2151.005	Specific tool for assembling the vandal proof collar
	209.00.00	Insert pair for thermostatic head RBM temperature limit
	306.00.02	2 wire NC servomotor Voltage: 230 Vac
	306.00.12	2 wire NC servomotor Voltage: 24 Vac
	306.00.42	4 wire NC servomotor Voltage: 230 Vac
	306.00.52	4 wire NC servomotor Voltage: 24 Vac
	2501.00.22	Programmable thermostatic command with weekly program, for valves with thermostatic option
	2962.00.02	Programming device
	2835.00.02	Thermostatic control for thermostatic valves. Remote control makes programming procedures easier during installation

TO KNOW MORE

Analytical procedure for determining the pressure drop for liquids with $\rho \approx 1 \text{ kg/dm}^3$

$$\Delta P = \left(\frac{Q}{Kvs} \right)^2 \times 10.000 \quad \text{valid for water with temp. from 0 to 30 } ^\circ\text{C}$$

ΔP correction for fluids with ρ different from 1 kg/dm^3

$$\Delta P' = \Delta P \times \rho'$$

Analytical procedure for valve dimensioning valid for liquids with $\rho \approx 1 \text{ kg/dm}^3$

$$Kvs = Q * \left(\frac{10000}{\Delta P} \right)^{0,5} \quad \text{valid for water with temp. from 0 to 30 } ^\circ\text{C}$$

Kvs correction for fluids with ρ different from 1 kg/dm^3

$$Kvs' = Kvs * \sqrt{\rho'}$$

KEY

- ΔP head loss in daPa (1daPa=10Pa)
- $\Delta P'$ correct head loss in daPa (1daPa=10Pa)
- ΔP_{max} pressure difference recommended for correct operation
- Q flow rate in m^3/h
- Kvs hydraulic feature in m^3/h ($1\text{m}^3/\text{h}=1.000 \text{ l/h}$)
- ρ' liquid density in kg/dm^3

SUMMARY CUSTOMIZATION COMBINATIONS TABLE VALVE / THERMOSTATIC HEAD

Code certified thermostatic head	Code certified valve	Code internal kit	Code sales kit	Reference certificate
590 (TL10)	31.04	1115	1115	01-RBM-TRV
590 (TL10)	32.04	3624.04.00	3624.04.00	01-RBM-TRV
590 (TL10)	48.04	1116	1116	01-RBM-TRV
590 (TL10)	31.04	3621.04.00	3621.04.00	01-RBM-TRV
720 (TL 30)	31.03	2078.03	2078.03	01-RBM-TRV
720 (TL 30)	31.04	2078.03	2078.03	01-RBM-TRV
720 (TL 30)	32.03	2079.03	2079.03	01-RBM-TRV
720 (TL 30)	32.04	2079.04	2079.04	01-RBM-TRV
720 (TL 30)	48.03	1342.03	1342.03	01-RBM-TRV
720 (TL 30)	48.04	1342.04	1342.04	01-RBM-TRV
720 (TL 30)	49.03	1343.03	1343.03	01-RBM-TRV
720 (TL 30)	49.04	1343.04	1343.04	01-RBM-TRV
2633 (TL70)	31.03	3570.03.00	3570.03.00	01-RBM-TRV
2633 (TL70)	31.04	3570.04.00	3570.04.00	01-RBM-TRV
2633 (TL70)	32.03	3571.03.00	3571.03.00	01-RBM-TRV
2633 (TL70)	32.04	3571.04.00	3571.04.00	01-RBM-TRV
2633 (TL70)	48.03	2756.03.00	2756.03.00	01-RBM-TRV
2633 (TL70)	48.04	2756.04.00	2756.04.00	04-RBM-TRV
2633 (TL70)	31.04	3835.04.00	3835.04.00	01-RBM-TRV
2634	48.04	2811.04.00	2811.04.00	01-RBM-TRV
2634	31.04	2812.04.00	2812.04.00	01-RBM-TRV
3087 (TL10W)	31.04	1128	1128	07-RBM-TRV
3614	31.04	1115TE	1115TE	08-RBM-TRV-A

SPECIFICATION ITEMS

SERIES 31

Angle valve with thermostatic option for iron pipe, complying with standard UNI-EN 215 (only diameters 3/8" and 1/2"). Nickel-plated brass body. Shutter with double seal. Seals in EPDM PEROX and NBR. Shockproof ABS handwheel. Threaded square connection F UNI-EN-ISO 228 for iron pipe. Connection to threaded terminal M UNI-EN-ISO 228 with pre-gasket ogive in PTFE (only diameters 3/8" and 1/2"). Max temperature 110 °C. Max operating pressure 10 bar. Available sizes 3/8" ÷ 3/4".

SERIES 32

Straight valve with thermostatic option for iron pipe, complying with standard UNI-EN 215 (only diameters 3/8" and 1/2"). Nickel-plated brass body. Shutter with double seal. Seals in EPDM PEROX and NBR. Shockproof ABS handwheel. Straight threaded connection F UNI-EN-ISO 228 for iron pipe. Connection to threaded terminal M UNI-EN-ISO 228 with pre-gasket ogive in PTFE (only diameters 3/8" and 1/2"). Max temperature 110 °C. Max operating pressure 10 bar. Available sizes 3/8" ÷ 3/4".

SERIES 48

Angle thermostatically-controlled radiator valve for copper, polyethylene and multilayer pipe, complying with standard UNI-EN 215. Nickel-plated brass body. Shutter with double seal. Seals in EPDM PEROX and NBR. Shockproof ABS handwheel. RBM Standard threaded square connection for copper, polyethylene and multilayer pipe. Connection to threaded terminal M UNI-EN-ISO 228 with pre-gasket ogive in PTFE. Max temperature 110 °C. Max operating pressure 10 bar. Available sizes 3/8" and 1/2".

SERIES 49

Straight thermostatically-controlled radiator valve for copper, polyethylene and multilayer pipe, complying with standard UNI-EN 215. Nickel-plated brass body. Shutter with double seal. Seals in EPDM PEROX and NBR. Shockproof ABS handwheel. RBM Standard threaded straight connection for copper, polyethylene and multilayer pipe. Connection to threaded terminal M UNI-EN-ISO 228 with pre-gasket ogive in PTFE. Max temperature 110 °C. Max operating pressure 10 bar. Available sizes 3/8" and 1/2".

SERIES 179

Inverse angle valve with thermostatic option for iron pipe. Nickel-plated brass body. Shutter with double seal. Seals in EPDM PEROX and NBR. Shockproof ABS handwheel. Threaded square connection F UNI-EN-ISO 228 for iron pipe. Connection to threaded terminal M UNI-EN-ISO 228 with pre-gasket ogive in PTFE. Max temperature 110 °C. Max operating pressure 10 bar. Available sizes 3/8" and 1/2".

SERIES 180

Inverse thermostatically-controlled radiator valve for copper, polyethylene and multilayer pipe. Nickel-plated brass body. Shutter with double seal. Seals in EPDM PEROX and NBR. Shockproof ABS handwheel. RBM Standard threaded square connection for copper, polyethylene and multilayer pipe. Connection to threaded terminal M UNI-EN-ISO 228 with pre-gasket ogive in PTFE. Max temperature 110 °C. Max operating pressure 10 bar. Available sizes 3/8" and 1/2".

SERIES 395

Angle thermostatically-controlled radiator valve for iron tube with reversible connections and orthogonal command. Nickel-plated brass body. Shutter with double seal. Seals in EPDM PEROX and NBR. Shockproof ABS handwheel. Threaded square connection F UNI-EN-ISO 228 for iron pipe. Connection to threaded terminal M UNI-EN-ISO 228 with pre-gasket ogive in PTFE. Max temperature 110 °C. Max operating pressure 10 bar. Available sizes 3/8" and 1/2".

SERIES 305 - 590 - 720 - 2633 - 2634 - 3087 - 3614

Thermostatic command for thermostatically-controlled radiator valve. Internal sensitive element with liquid expansion. Prearranged for temperature limitation and anti-tampering blockage. Room temperature max 50 °C. Anti-freeze triggering (*) 7°C. Setting field (1÷5) 10... 30 °C. Hysteresis 0.3 °C. Max differential pressure (head mounted on valve) 1 bar. Thermostatic ethyl-acetate bulb liquid.

RBM spa reserves the right to improve and change the described products and related technical data at any moment and without prior notice: always refer to the instructions attached with the supplied components; this sheet is an aid, should the instructions be extremely schematic. Our technical office is always at your disposal for any doubt, problem or explanation.

RBM Spa

Via S. Giuseppe, 1 • 25075 Nave (Brescia) Italy
Tel 030 2537211 • Fax 030 2531798 • info@rbm.eu • www.rbm.eu

 @rbmspa  RBM S.p.A.  rbm_spa_  Rbm Italia